



RESIDENTIAL
ALUMINIUM WINDOW

www.Durabold.net



DURABOLD is a brand that offers Storefront & Windows.

We offer products that provide benefits for Commercial Storefront & Residential:

- Modern design that suitable for any style design.
- Suitable for interior and exterior.
- Reduce noise & heat from outside (more efficient).
- Easy to install (low cost).
- Easy to clean.
- Export Quality - Made in Indonesia.
- Meet with USA standards.



Division of Young Corporation
Reputable Properties Development & Industries
in USA & Indonesia with 38 Years of Experience

TABLE OF --- CONTENTS

Type 1000 Aluminium Fix Window	03
Type 5000 Aluminium Swing Window	07
Type 5000 Aluminium Fix Window & Swing Door	10
Type 7100 Aluminium Sliding Folding Door	13
Type 7250 Aluminium Sliding Folding Door With Louver	16
Type 8500 Aluminium Sliding Window	19
Type 8500 Aluminium Sliding Door Slim	22
Type 8770 Aluminium Sliding Door Maxi	25
Type 8795 Aluminium Tilt & Turn Window	28

TYPE 1000 ALUMINIUM FIX WINDOW

www.Durabold.net





TYPE 1000 ALUMINIUM FIX WINDOW

Bring natural light into your space like never before with a clean, modern solution designed to deliver beauty and performance without compromise.

With no operable parts, this fixed window style offers a minimalist profile that frames the outside world like a picture—ideal for creating feature walls, maximizing daylight, and maintaining energy efficiency.

Its rigid, sealed construction enhances durability and insulation, making it a reliable choice for large-scale developments such as multifamily residences, hospitality settings, and commercial projects. The clean lines and expansive glass surface are equally at home in contemporary single-family homes or upscale high-rises.



TYPE 1000 ALUMINIUM FIX WINDOW

PRODUCT SPECIFICATION

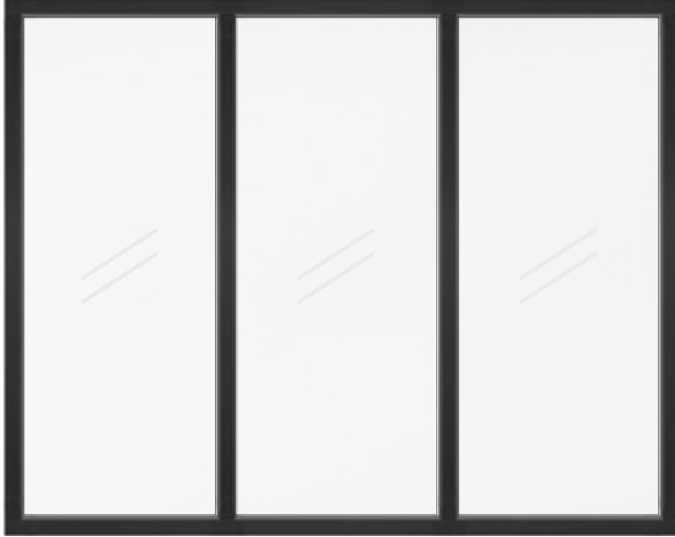

Profile : 100
Glass : IGU
(5mm clear tempered + 9A + 5mm clear tempered)

FRAME COLOR OPTIONS



WHITE



BLACK

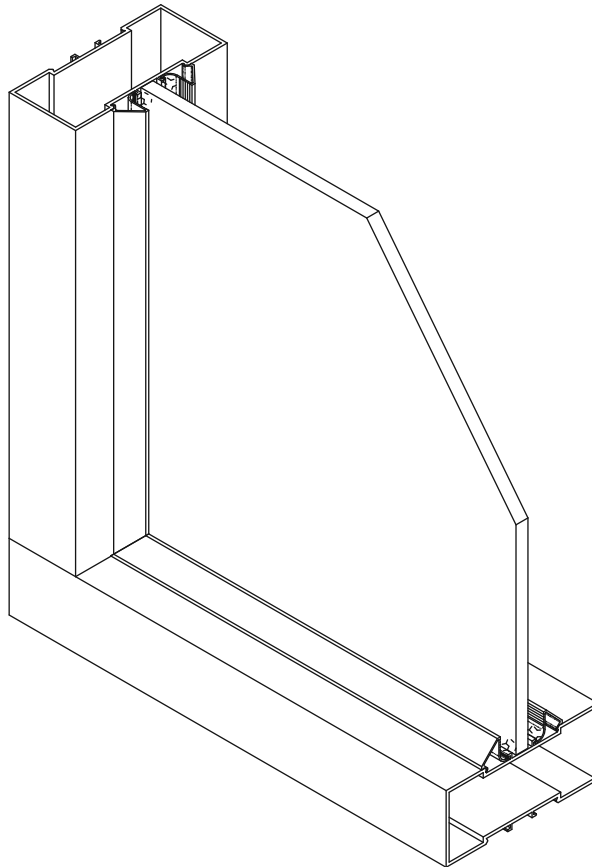



**TYPE 5000
ALUMINIUM SWING WINDOW**



TYPE 5000 ALUMINIUM SWING WINDOW

Achieve the perfect balance of form, function, and energy efficiency. The inward or outward opening mechanism makes it easy to operate while allowing for generous airflow and natural ventilation. With high performance aluminium frames and dependable sealing, this design ensures comfort and weather protection over the long term.

Its versatility makes it a great fit for both classic homes and contemporary multifamily complexes, especially in kitchens, bathrooms, and bedrooms. Whether you're looking for a timeless look or a modern upgrade, this option brings elegance, strength, and practicality to any build.



TYPE 5000 ALUMINIUM SWING WINDOW

PRODUCT SPECIFICATION



Closed



Opened

Profile : 50
Glass : IGU
(5mm clear tempered + 9A + 5mm clear tempered)

FRAME COLOR OPTIONS



WHITE



BLACK



TYPE 5000 ALUMINIUM FIX WINDOW & SWING DOOR

A smart, all in one solution for multifamily units pairing natural light with reliable access. The fixed panel enhances brightness and views, while the swing door ensures secure, low maintenance entry. Ideal for balconies, patios, or shared corridors.



TYPE 5000 ALUMINIUM FIX WINDOW & SWING DOOR

PRODUCT SPECIFICATION



Closed



Opened

Profile : 50
Glass : IGU
(5mm clear tempered + 9A + 5mm clear tempered)

FRAME COLOR OPTIONS



WHITE



BLACK

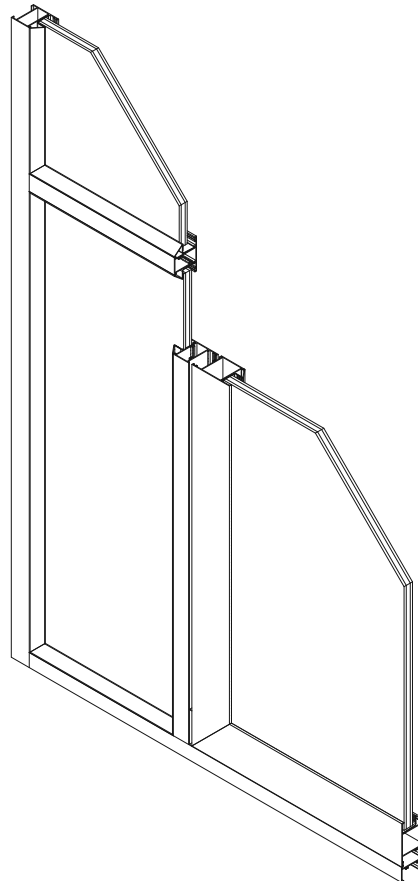











TYPE 7100
ALUMINIUM FOLDING DOOR



TYPE 7100 ALUMINIUM FOLDING DOOR

Fold away entire walls with ease to open up indoor-outdoor living like never before. Engineered for smooth operation and thermal performance, this door system is ideal for luxury homes, amenity lounges, and multifamily courtyards. It blends elegant design with secure locking systems and effortless function.

 <p>Outside Handle & Lock</p>	 <p>Inside Handle & Lock</p>	 <p>Adjustable Locking Handle</p>	 <p>Hinges</p>
 <p>Adjustable Handle</p>	 <p>Hinges & Lock System Top</p>	 <p>Hinges & Lock System Bottom</p>	 <p>Hinges & Catrol Bottom</p>

TYPE 7100 ALUMINIUM FOLDING DOOR

PRODUCT SPECIFICATION



Closed Condition



Opened Condition

Profile : 71
Glass : IGU
(5mm clear tempered + 9A + 5mm clear tempered)

FRAME COLOR OPTIONS



WHITE



BLACK

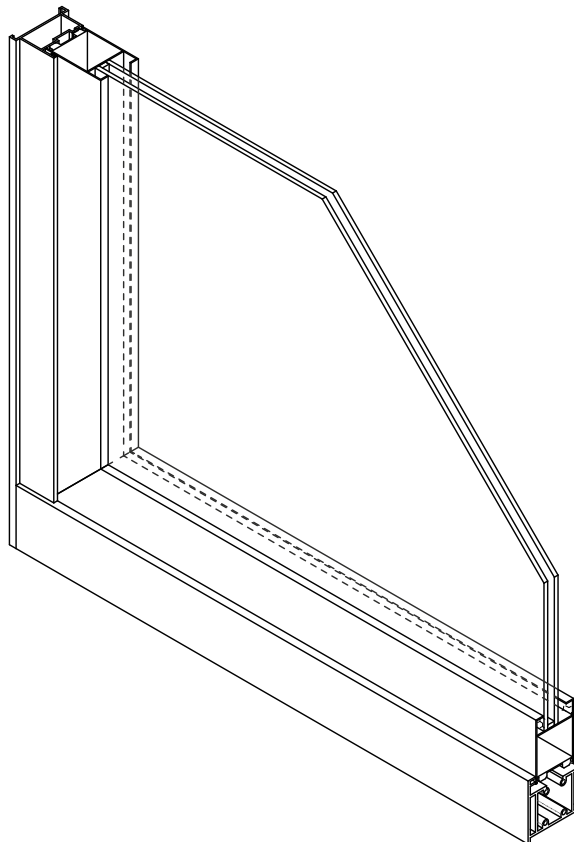

TYPE 7250 ALUMINIUM FOLDING DOOR WITH LOUVER

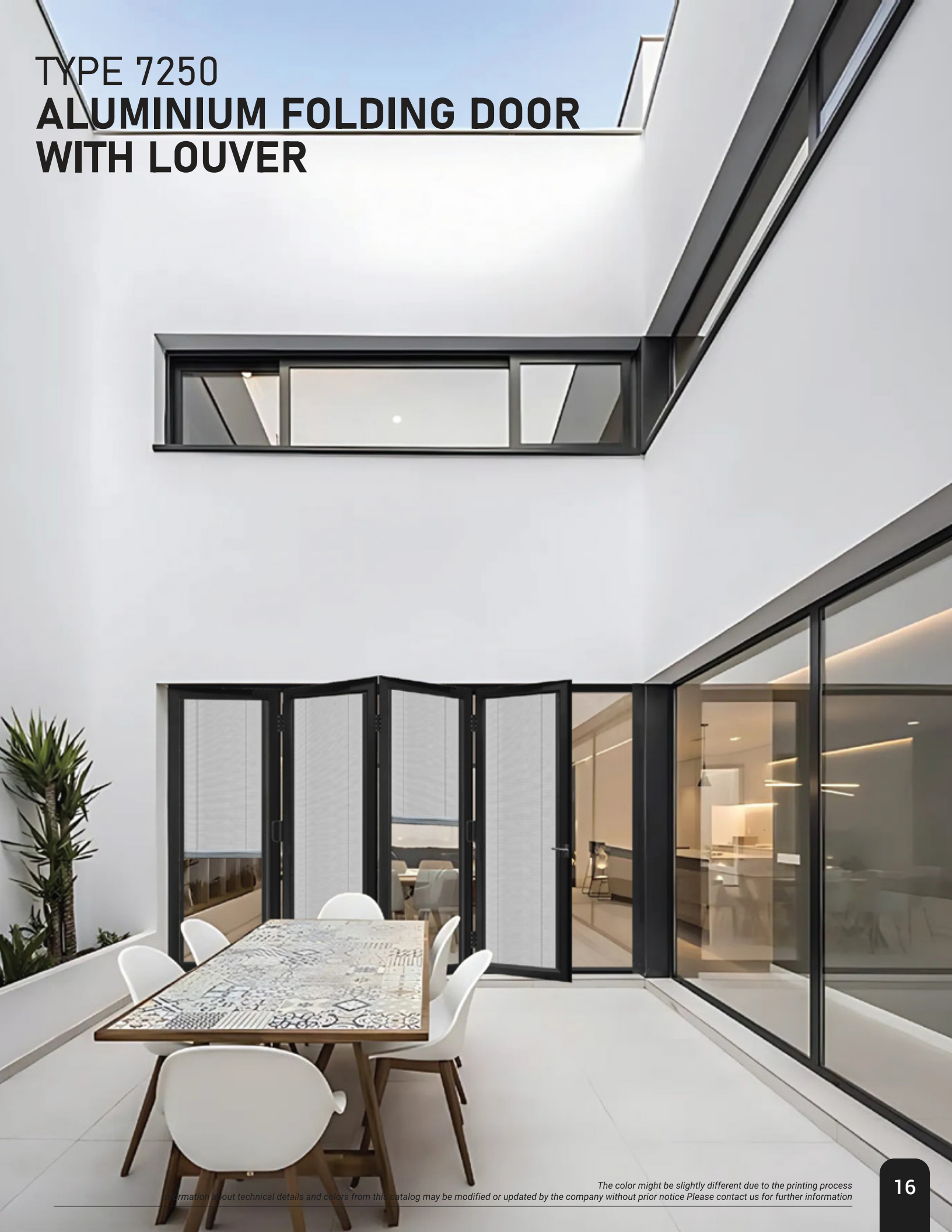







The color might be slightly different due to the printing process
Information about technical details and colors from this catalog may be modified or updated by the company without prior notice Please contact us for further information



TYPE 7250 ALUMINIUM FOLDING DOOR WITH LOUVER

Designed for high traffic multifamily living, this space saving sliding window offers smooth operation, thermal efficiency, and noise reduction. A cost effective, long lasting choice for apartments or student housing.

				
Outside Handle & Lock	Inside Handle & Lock	Adjustable Locking Handle	Hinges	Adjustable Handle
				
Hinges & Lock System Top	Hinges & Lock System Bottom	Hinges & Catrol Bottom	Louver	

TYPE 7250 ALUMINIUM FOLDING DOOR WITH LOUVER

PRODUCT SPECIFICATION



Closed Condition



Opened Condition

Profile : 3750
Glass : IGU
(5mm clear tempered + 15A + 5mm clear tempered)

FRAME COLOR OPTIONS



WHITE



BLACK

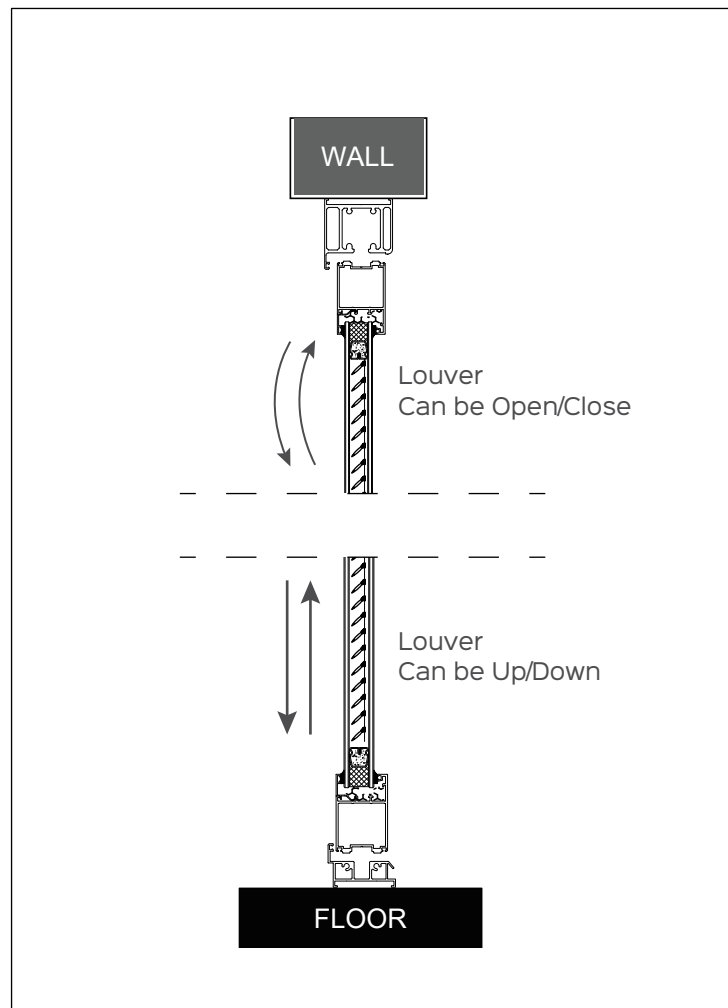



TYPE 8500 ALUMINIUM SLIDING WINDOW

Enjoy effortless horizontal movement and excellent ventilation, all within a slim, space-saving profile. This window style is perfect for wide openings or compact layouts, delivering both performance and aesthetic appeal. It's a reliable, energy conscious choice for high-density housing, modern apartments, and single-family homes. Choose from White or Black to complement your architecture.



TYPE 8500
ALUMINIUM SLIDING WINDOW



**TYPE 8500
ALUMINIUM SLIDING WINDOW**

PRODUCT SPECIFICATION



Closed



Opened

Profile : 85

Glass : IGU

(5mm clear tempered + 9A + 5mm clear tempered)

FRAME COLOR OPTIONS



WHITE



BLACK



TYPE 8500
ALUMINIUM SLIDING DOOR SLIM



TYPE 8500 ALUMINIUM SLIDING DOOR SLIM

Create seamless transitions between indoor and outdoor spaces with wide glass panels that glide effortlessly. This door type brings in ample daylight while offering insulation, security, and visual impact. Perfect for patios, balconies, or open-concept living areas in both residential and multifamily settings.

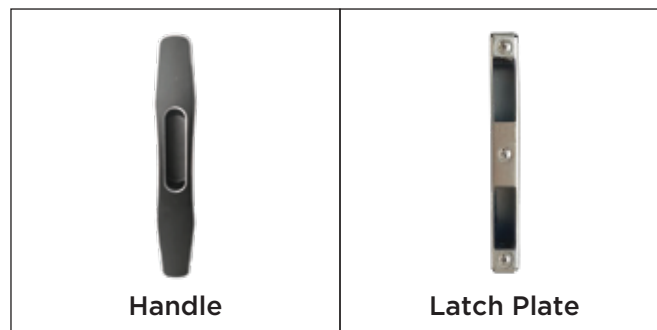



TYPE 8500 ALUMINIUM SLIDING DOOR SLIM

PRODUCT SPECIFICATION



Closed Condition



Opened Condition

SLIDING DOOR SLIM

Profile : 85

Glass : IGU

(5mm clear tempered + 9A + 5mm clear tempered)



**TYPE 8500
ALUMINIUM SLIDING DOOR MAXI**



TYPE 8500 ALUMINIUM SLIDING DOOR MAXI

Create seamless transitions between indoor and outdoor spaces with wide glass panels that glide effortlessly. This door type brings in ample daylight while offering insulation, security, and visual impact. Perfect for patios, balconies, or open-concept living areas in both residential and multifamily settings.

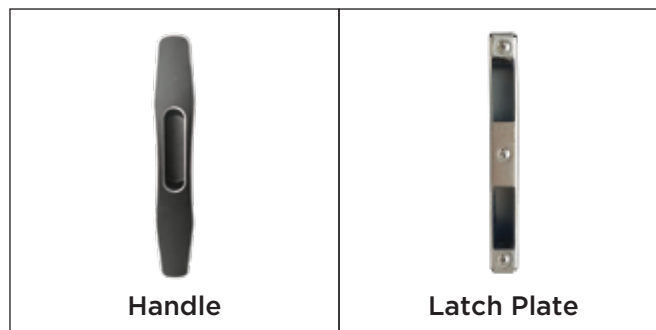



TYPE 8500 ALUMINIUM SLIDING DOOR MAXI

PRODUCT SPECIFICATION



Closed Condition



Opened Condition

SLIDING DOOR MAXI

Profile : 8770

Glass : IGU

(5mm clear tempered + 15A + 5mm clear tempered)

FRAME COLOR OPTIONS



WHITE



BLACK



TYPE 8795 ALUMINIUM TILT & TURN WINDOW

Tilt for gentle ventilation or turn open for full access, all from one intelligent, space-efficient frame. This versatile design is ideal for high-rise living, contemporary homes, and energy-efficient developments. Combining ease of use with premium insulation and clean aesthetics, it delivers on both form and function.



TYPE 8795 ALUMINIUM TILT & TURN WINDOW



TYPE 8795 ALUMINIUM TILT & TURN WINDOW

PRODUCT SPECIFICATION



Opened 1

Opened 2

Profile : 8795
Glass : IGU
(5mm clear tempered + 27A + 5mm clear tempered)

FRAME COLOR OPTIONS



WHITE



BLACK



If you have any questions about our products or how to place an order please contact us



4261 Communications Drive
Norcross, GA 30093, USA
Email: durabold@youngcorporation.com
Phone : +1 (323) 722-6868



88 Konrad Crescent #2
Markham, ON L3R 8T7, Canada
Email: durabold@youngcorporation.com



Jl. Sunset Road No.85 X,
Seminyak, Kec. Kuta, Kab. Badung
Bali 80361
Email: sales@homestyle.co.id



Ruko Prominence 38F No. 41-42, Alam Sutera,
Kec. Pinang, Kota Tangerang,
Banten 15143, Indonesia
Email: sales@homestyle.co.id

www.Durabold.net



Division of YOUNG CORPORATION